

, - 18-20

(30.06.2015.)

3/2015

, 2015.

3/2015,

29/2013) :), 39. 61. (, . ” . 124/2012,
 6. (, . ” .
 : 774/1-1 04.06.2015.
 : 774/1-2 04.06.2015.

3/2015

:

I

II

III

-
-
-

,

,

,

,

,

IV

V

VI

VII

2

1

VIII

1

IX

X

I

1. www.f.bg.ac.rs, : 100050474, : 07003269. 18-20,

2.

3.

1 -
2 -

4.

75. 76.

5.

6.

12,00

03.07.2015.

7.

12,30

03.07.2015.
18-20,

I,

8.

10

9.

, e – mail: nabavk @f.bg.ac.rs.

II

1. ,

, , 18-20.
20

.(1)

20

,

.(2)

.(2)

2.

3.

, 7 ,

, 5 ,

4.

(1)

je 24 ,

je .(2)

III

75. 76.

:

1. _____

75.

- , ;
 - , , , ;
 ;
 - , ;
 - , ;
 , (.75. .2.). ,

2. _____

76.

: , :
 - 7 6 .
 :
 - / 2014. , ,
 :
 : (,)
 : 3 .

_____ :

75. 1. .1) 4) , 80. ,
 75. 1. .1) 4) , ,

. 77. 4. ,
,

1.

: a

:

2.

:

3.

_____:

. 77. 4. ,

77. 4. ,

, ,

75. 76.
3/2015. ,

:

1. _____ ,
(.75. .1. .1));

2. _____ ,

, (.75. .1. .2));

3. _____ ,
(.75. .1. .3));

4. _____ ,
(.75. .1. .4));

_____ (.76.).

1. _____ 7 6 ;

2. / 2014. ,

3. _____ ; (,

);

4. 3 .

..

:

,

1) 4) ,

77. 4. , ,

75. 76.
3/2015,
, :

1. (.75. .1. .1)); ,

2. , , (.75. .1. .2));

3. (.75. .1. .3));

4. , (.75. .1. .4)).

..

: .

75. 2.

_____ () ,

:

,

,

,

.

• •

:

,

.

.

III

1.

2.

(:)

1.

2.

3.

4.

5.

2;

6.

7.

8.

3.

60

4.

5.

50%.

5

6.

1)

2)

3)

4)

5)

6)

7)

()

.81.

7.

8.

10 / ,

9.

9.1.

9.2.

“,

30

- 1 - 10 %
- 2 - 10 %

9.3.

1

10.

11.

18-20.

20

.(1)

20

.(2)

.(2)

12.

13.

7 ,

5 ,

14.

.(1)

je 24 ,

je .(2)

15.

16.

“.

”

17.

18.

1 -
2 -

;

19.

20.

21.

107.

22.

()

23.

8

24.

5

3 ()

18-20

nabavk@f.bg.ac.rs

20.

25.

26.

27.

() , , . ,
() , , ,
() , .

28.

14. .

29.

nabavk@f.bg.ac.rs,

011/2639-356 (

8,00

16,00

e-mail
)

2

3

40.000,00

- 151. 1. 6) , :
- 1) : 156.
- (1) ;
- (2) ;
- (3) 156. ;
- (4) : 840-742221843-57;
- (5) 153 253;
- (6) : 97 50-016,
- (7) : ;
- (8) : ;
- (9) , ;
- (10) . ;
- 2) , , ;
- 3) , , ;

4) , (,)
. 138. - 167. .

30.

8

149. .

, 112. 2. 5) .

V

3/2015,

1. _____ (_____):

)

) _____ :

) _____ :

2. _____ (_____):

)

) _____ : (_____)

1) 1 - _____ ;

2) 2 - _____ .

3. _____ (_____) (_____ 60 _____), _____ .

..

- -

3/2015,

:	
:	
:	
():	
:	
(e-mail):	
:	
:	
:	
:	

..

- -

3/2015,

-

:	
:	
:	
:	
:	
:	
:	
:	
:	
:	
:	
:	
:	
:	
50 %):	(
:	

.. - -

_____ : ” “ , ,

:	
:	
:	
:	
:	
:	
:	
:	
:	
:	
:	
:	
:	
:	
:	

. . - -

_____ : ” “ _____
 , , . ,

 3/2015,

1-

		.	.	×	.	-	=	-
1	2	3	4		5			6
1	80cm. 5cm. RADNI STO I, .3.							
			2	×			=	
2	80cm. 5cm. RADNI STO IA, .4.							
			1	×			=	
3	80cm. RADNI STO II, .5.							
			1	×			=	

3/2015,

1	2	3	4	×	5	=	6
4	54cm. 35x45, .5A.						
			4	×		=	
5	283cm. POLICAMA III, 109x42, PLAKAR SA .6.						
			1	×		=	
6	120cm, POLICE IV, 260x30cm, 130cm .7.						
			1	×		=	

				×		=	
1	2	3	4		5		6
7	120cm, 132x30cm, 130cm POLICE V, .8.						
			1	×		=	
8	70cm. 18mm, 15cm 10cm. , 5 165x70cm. .9.						
			2	×		=	
9	55cm. 50cm,						
			1	×		=	

1	2	3	4	×	5	=	6	
10	80cm. 5cm. 120x60, .10.							
			10	×		=		
11	95cm. 5cm. 120x60, .11.							
			3	×		=		
							:	

20), _____ (_____ -
 _____ : _____ ,
 _____ .
 _____ .. _____ - _____

RADNI STO I (2 kom)
list br.3

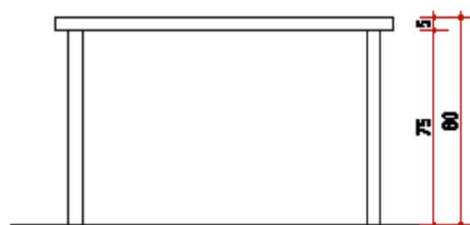

PRESEK 1-1



POGLED A

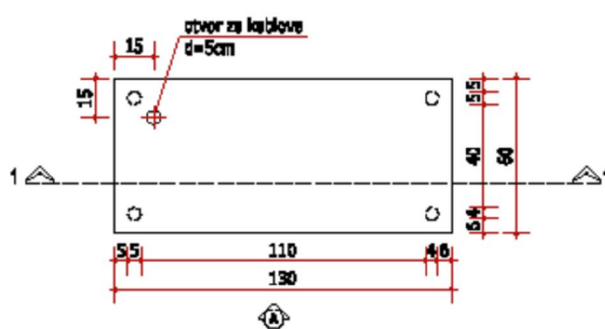

RADNI STO IA (1 kom)
list br.4

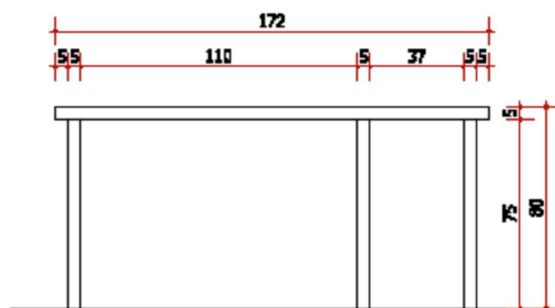

PRESEK 1-1

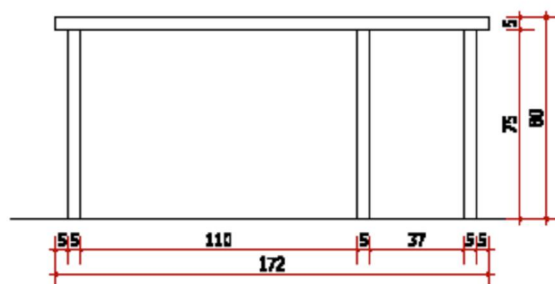

POGLED A

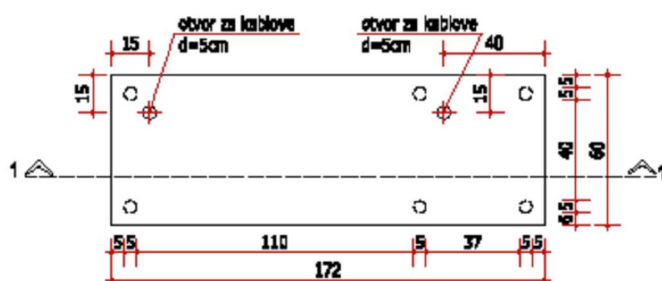

RADNI STO II (1 kom)
list br.5

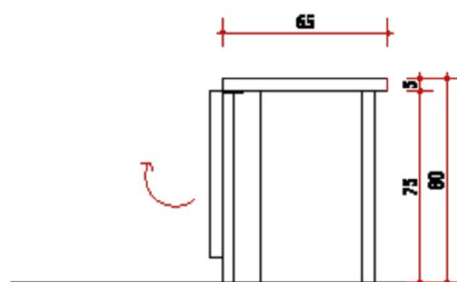
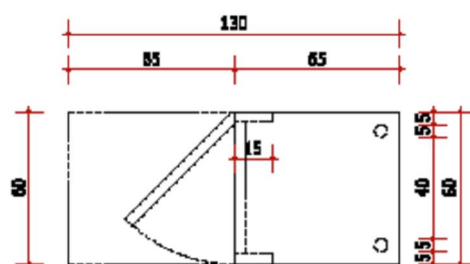

FIOKE (4 kom)
list br.5A

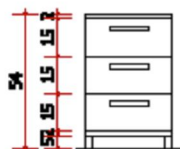
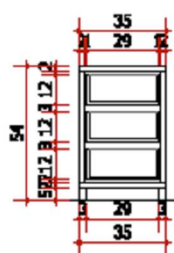

PLAKAR SA POLICAMA III (1 kom)
list br.6

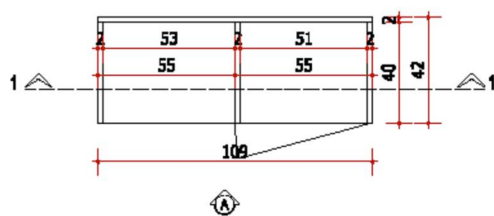
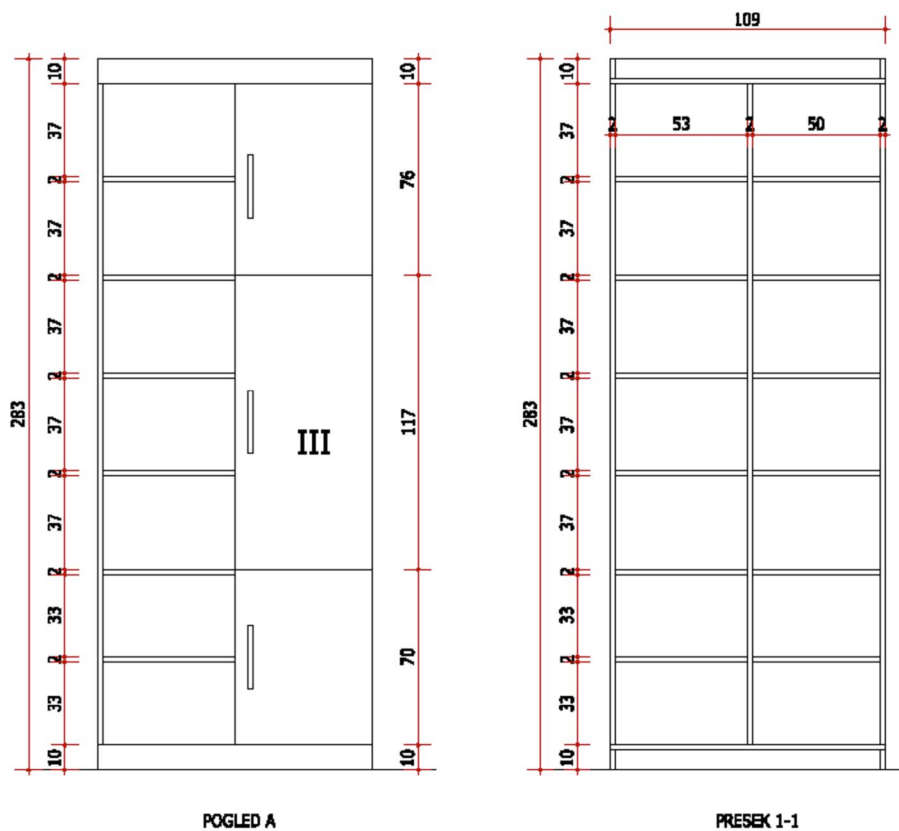

POLICE IV (1 kom)
list br.7

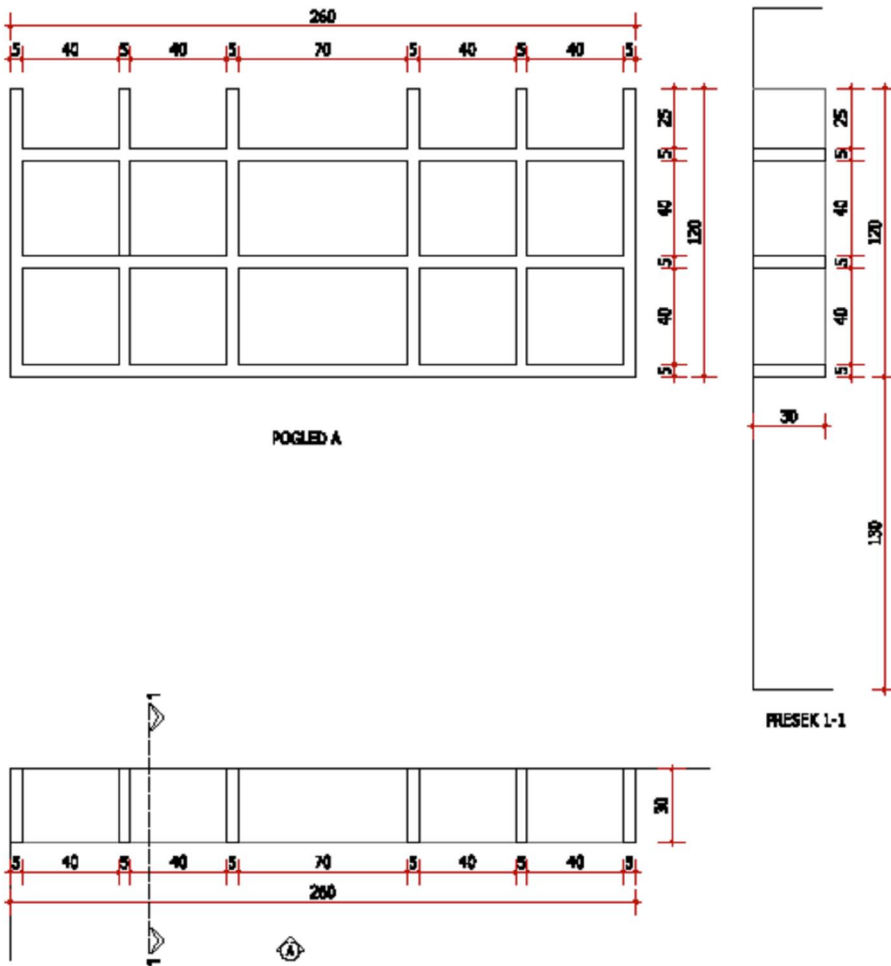

POLICE V (1 kom)
list br.8

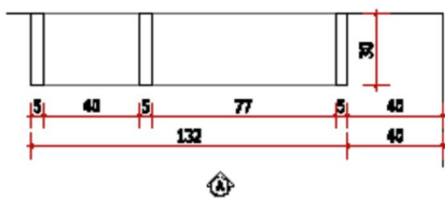
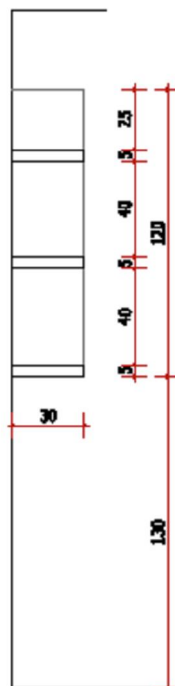
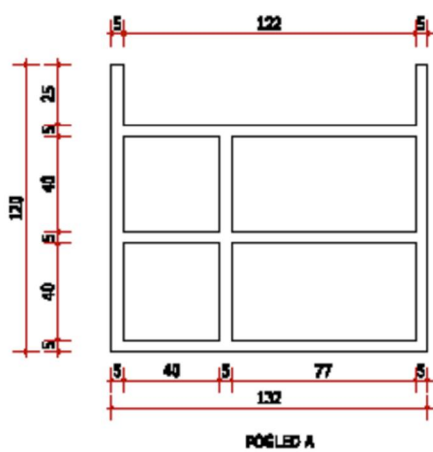

CIVILUK (1 kom)
list br.9

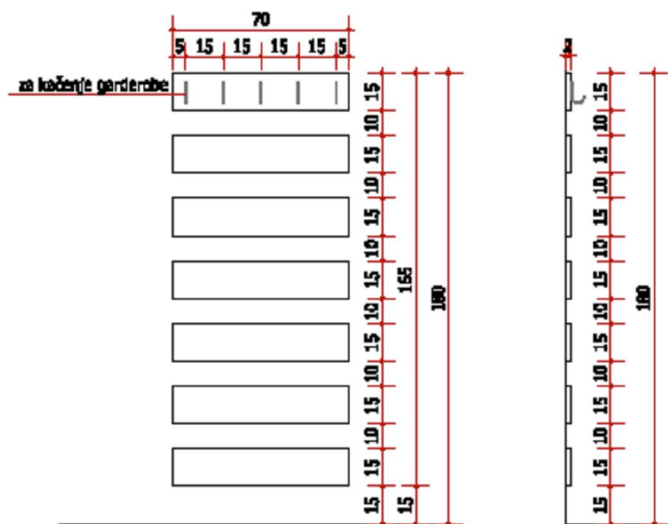

STO OD UNIVERA (10 kom)
list br.10

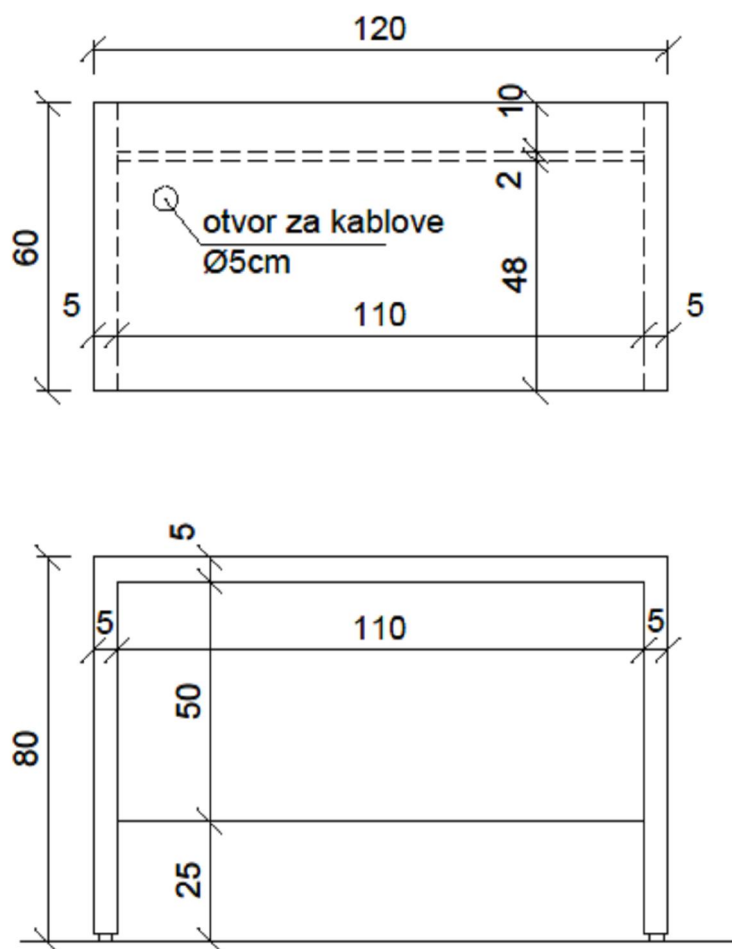

STO OD UNIVERA (3 kom)
list br.11

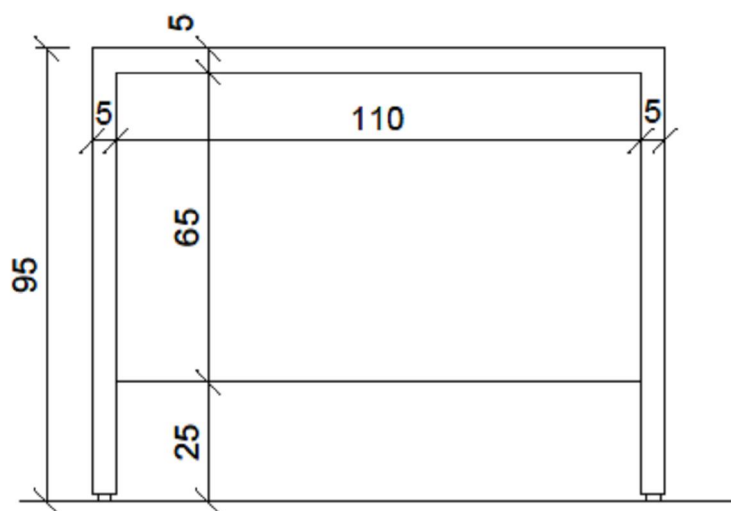
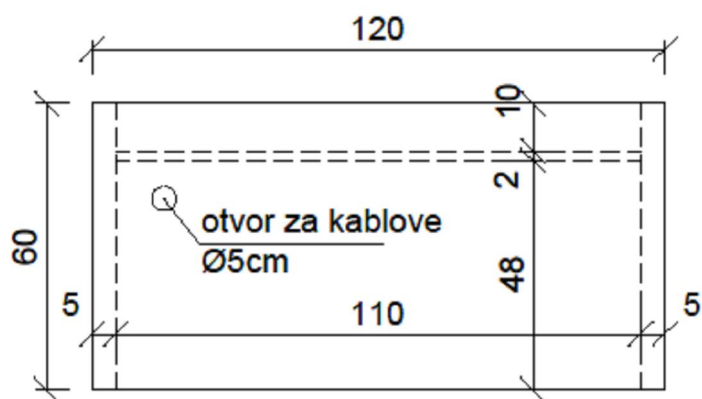

2 -

1	2	3	4	5	×	6	=	7
1.	<p>197 01</p> <p>60cm, 53cm.</p> <p>120-128cm,</p> <p>50cm,</p> <p>45-</p> 							
				4	×		=	

1	2	3	4	5	×	6	=	7
2.	 <p>220-3</p> <p>63cm, 82cm, 72cm, 43cm.</p>							
				1	×		=	

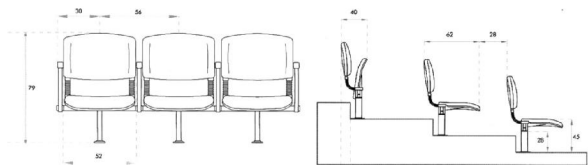
1	2	3	4	5	×	6	=	7
3.								
				150	×		=	
		:						

_____ (_____ - _____ 20 _____),

_____ : _____ ,

_____ .

..

-

-

3/2015,

, 18-20

VI

_____ , :

1. 18-20, : 100050474, (: 07003269) , , , .

2. _____ , _____ , .
_____, _____ , _____ (_____ : _____)
(: _____ , _____)

:

-
(" _____ ", . 124/2012) , 3/2015,
: 774/1-1 04.06.2015. .
- _____ , : 1 -
2 - _____ (/ _____) (_____ ,
- _____) , _____ ;
- (_____) , 1/ 2. _____) ,
- _____ 113.
;
- (_____) .

1.

: (_____)

2.

() .

(2)

(1),

10 ,

3.

” “,

10%

30

4.

” “,

5%

30

(1)

5.

a a

6.

() ,

/

18-20.

1

7.

1.

8.

7

(1)

(_____).

je .(2)

10.

11.

77.

12.

13.

14.

15

15.

16.

3()

6()

_____ ,

_____ ,

VII

1 - / 2 -

1 -

/ 2 - ,

:

- , ”

“ , ,

, 10% , - , 10

, , .

. . - -

VIII

1 -

1 - , :

-
," " ,
,
30 , 5% , - ,
 , ,

.. - -

X

26.

, _____ ,
()

:

3/2015,

,

,

.

..

-

-

:

,

.

3/2015,

-